

FERRARI 459

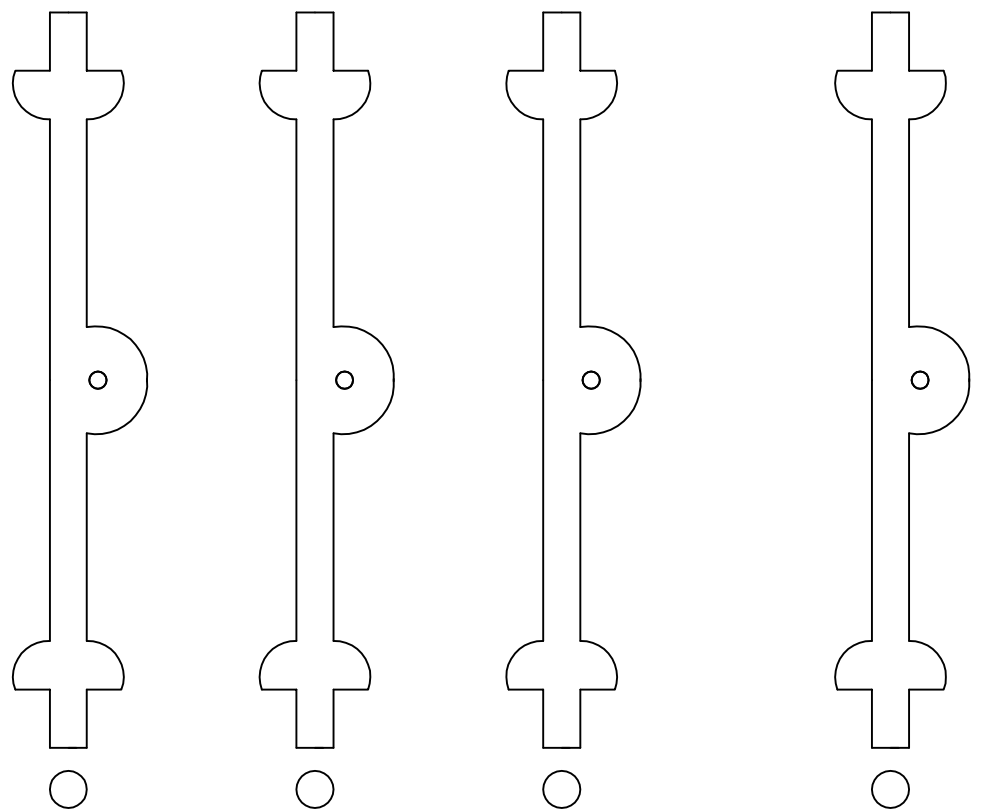

A3 4 mm

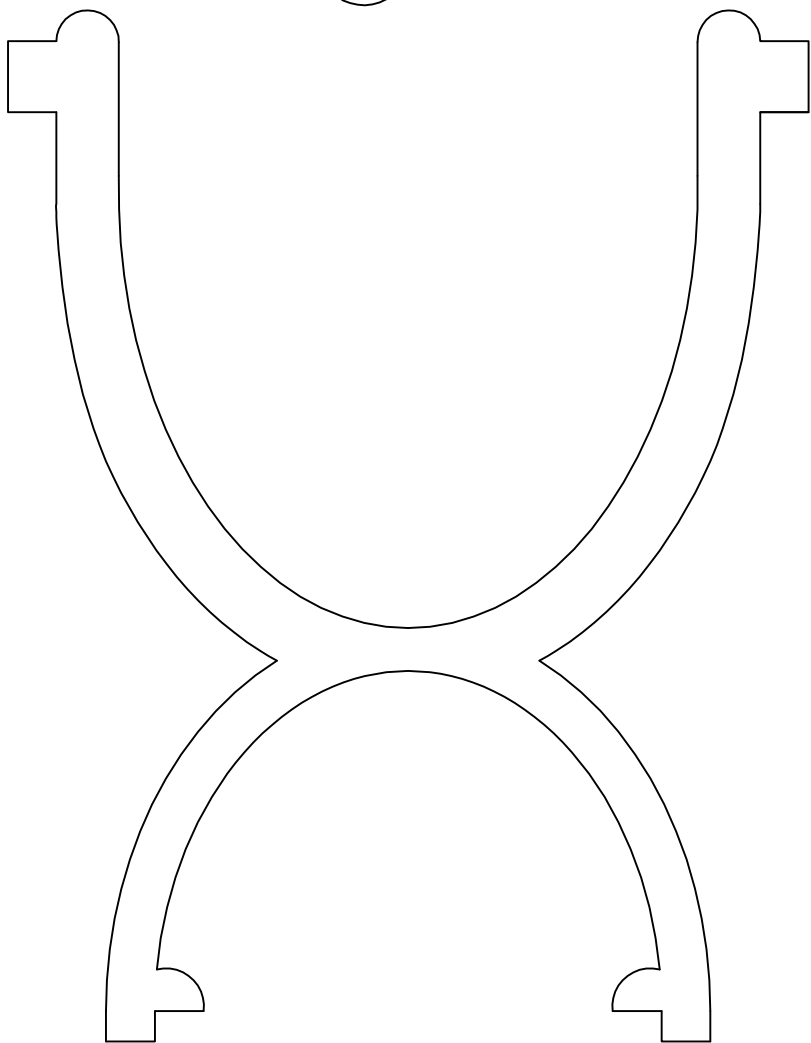
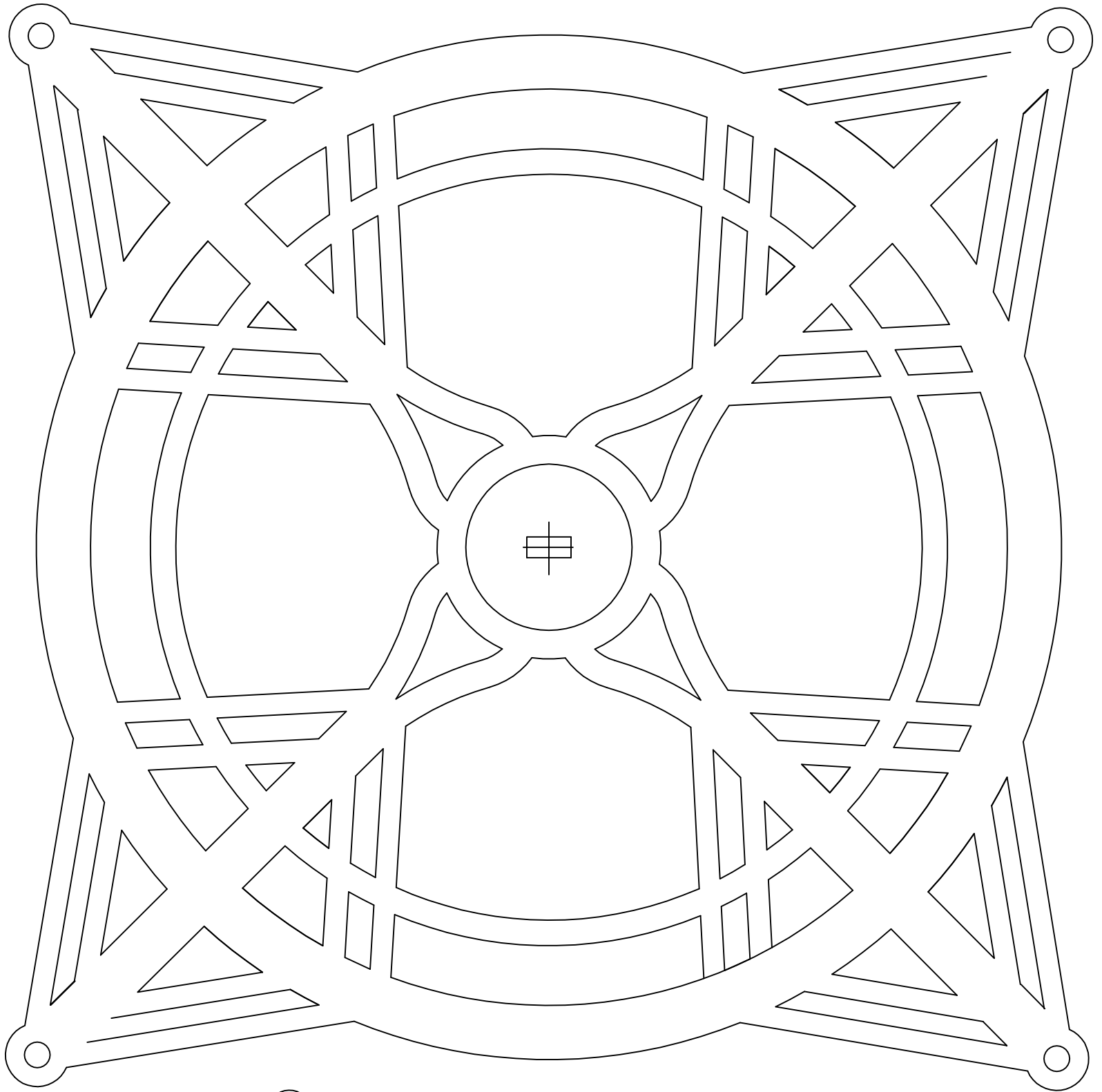
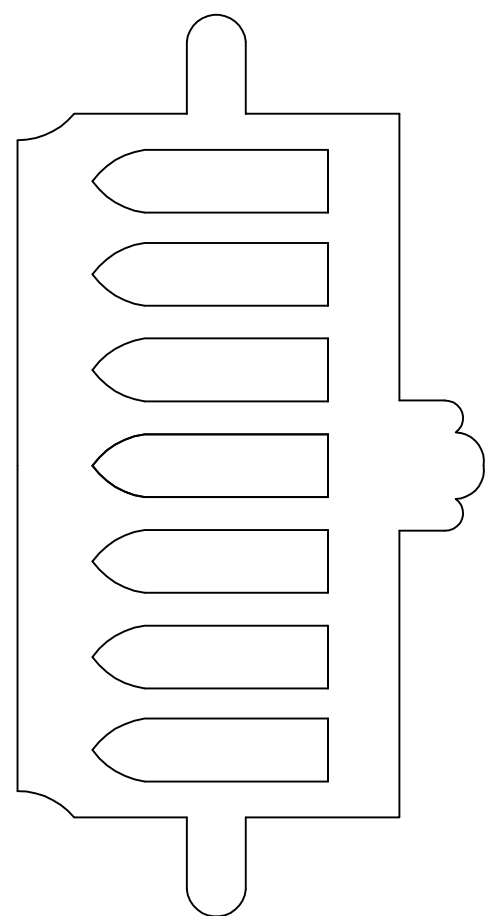
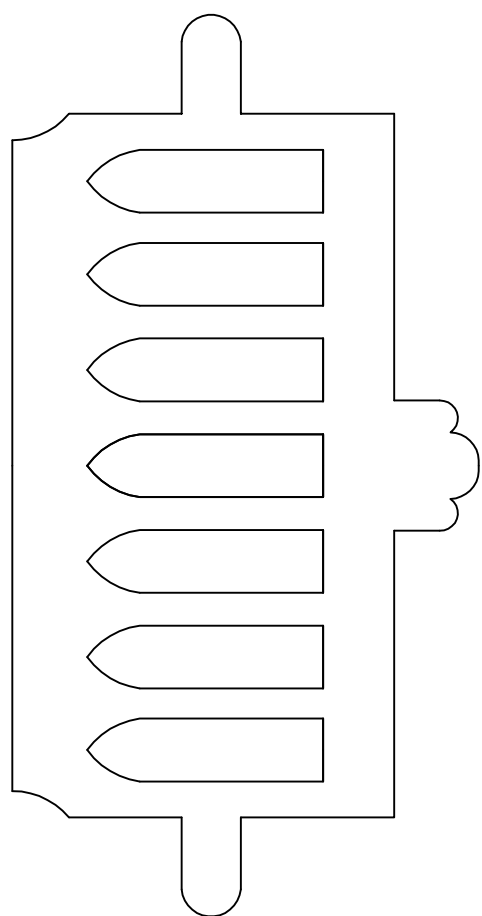
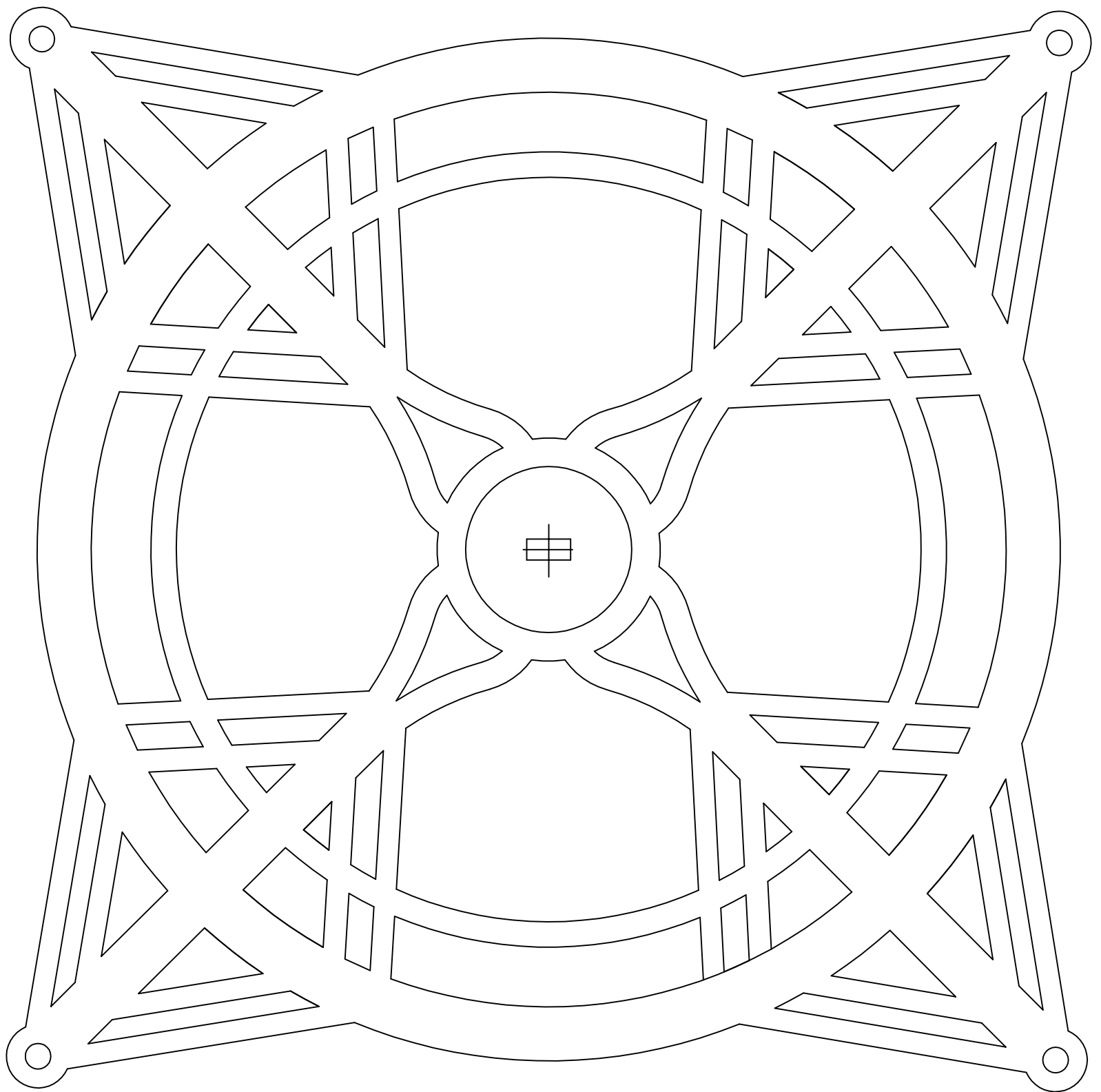
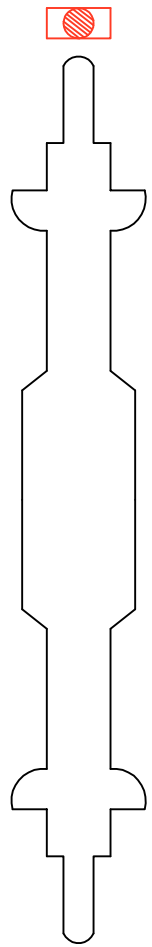

A3 4 mm

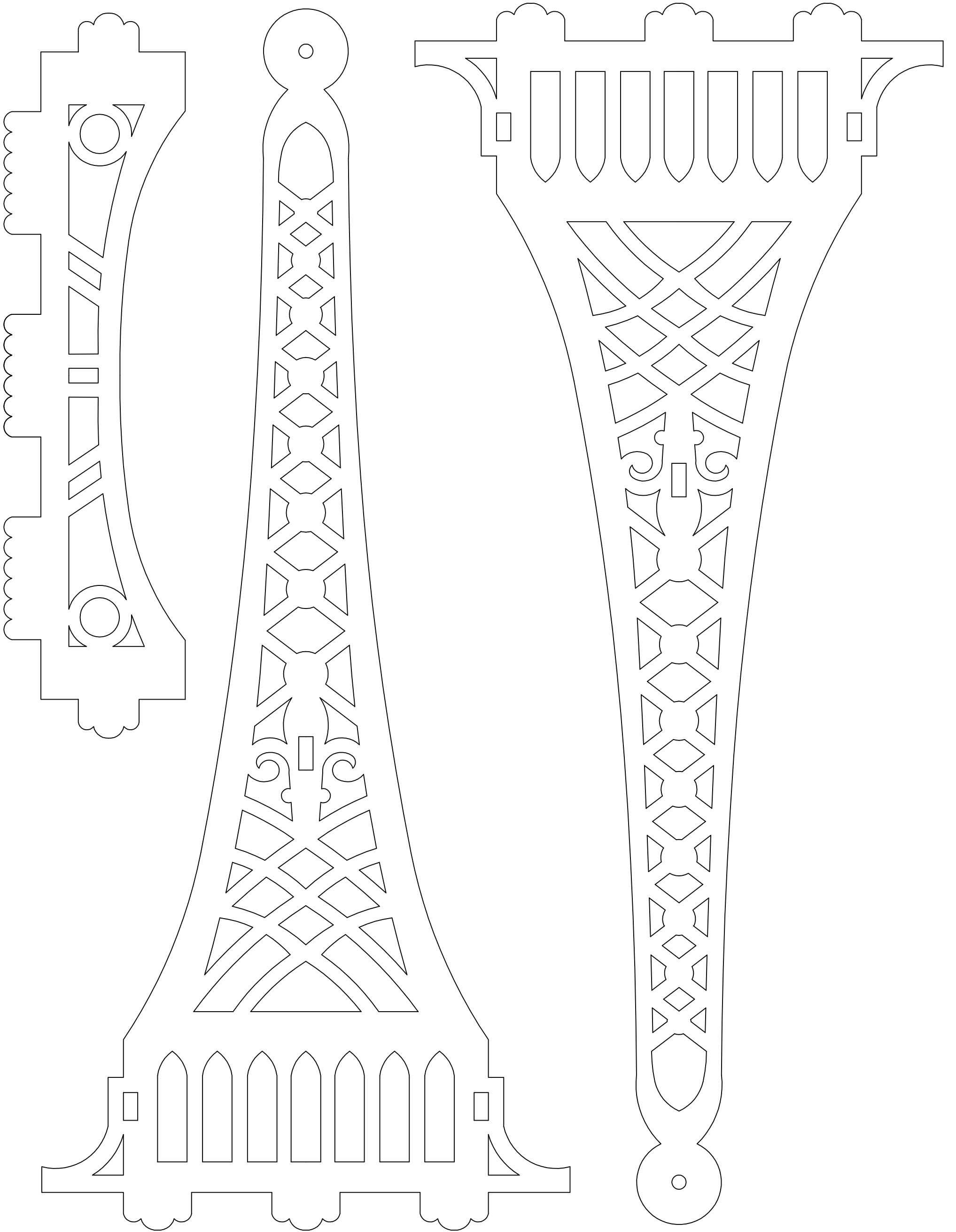

A3 4 mm

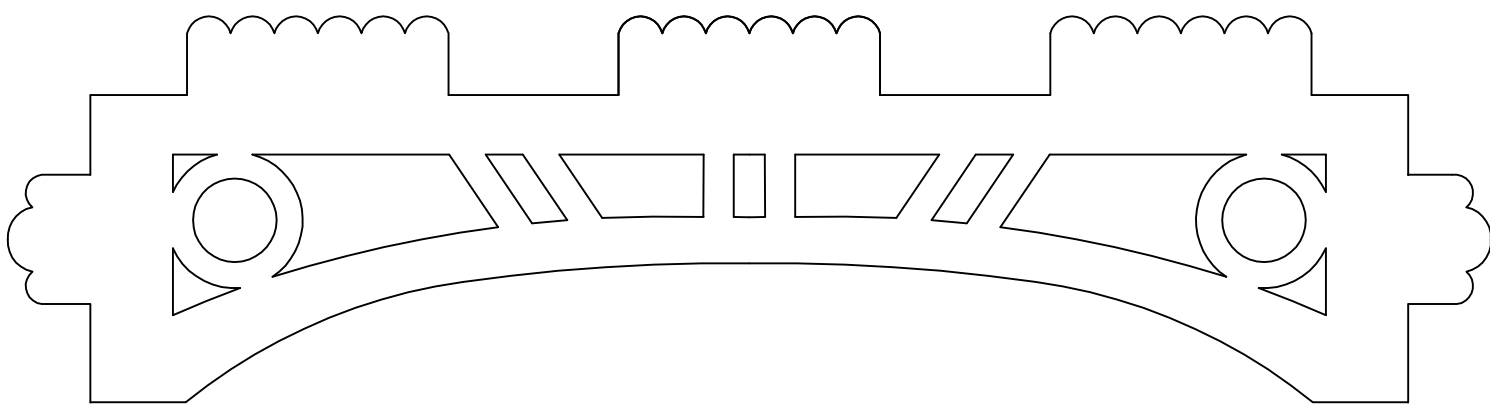
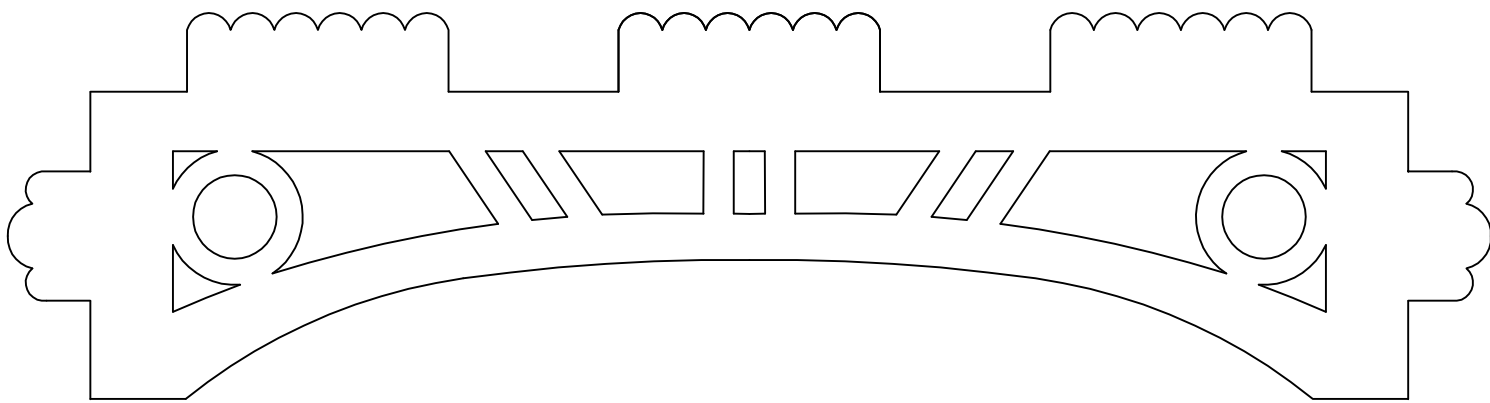
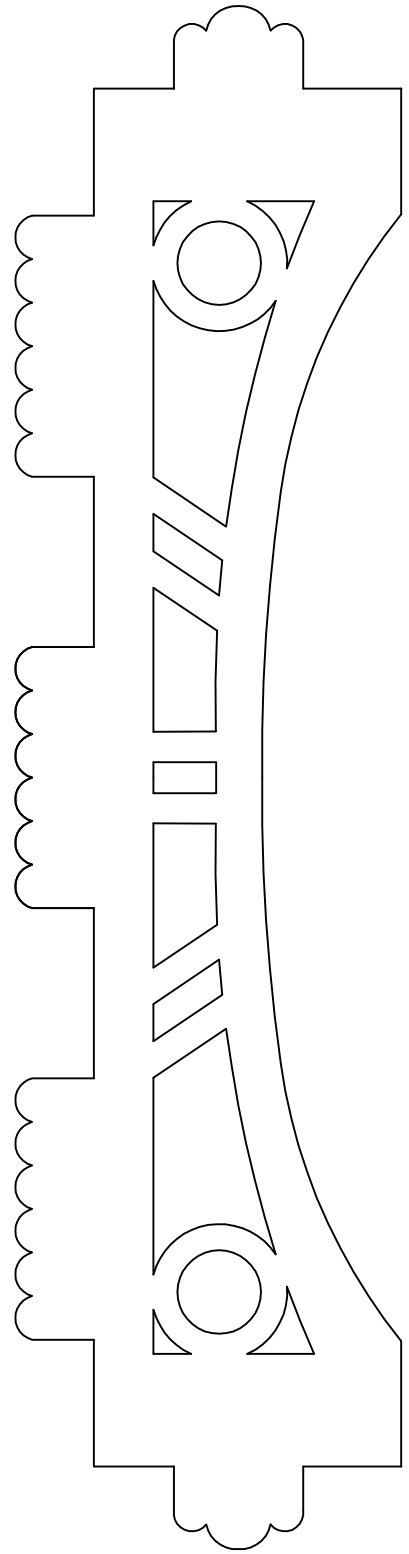
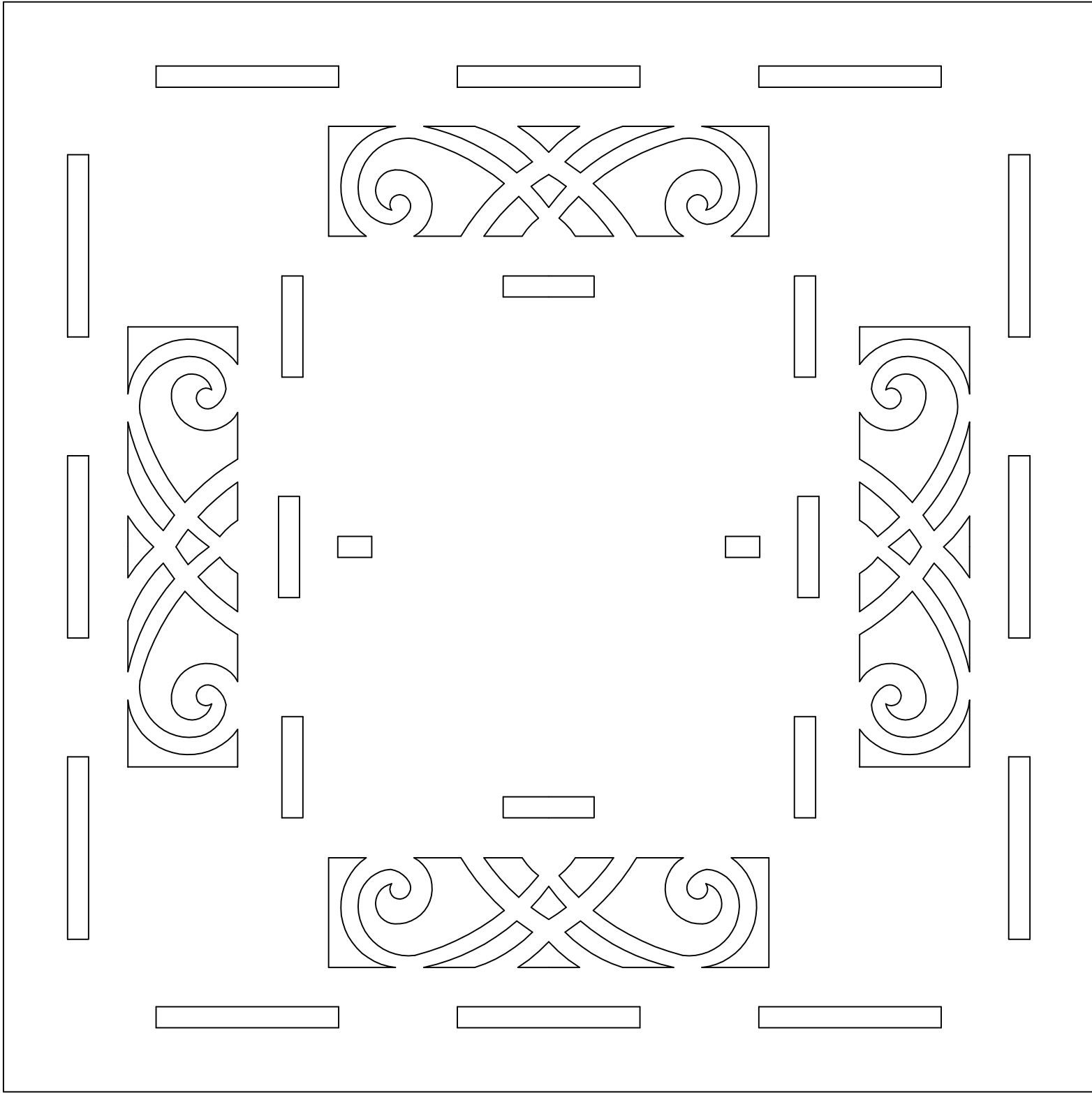

A3 4 mm

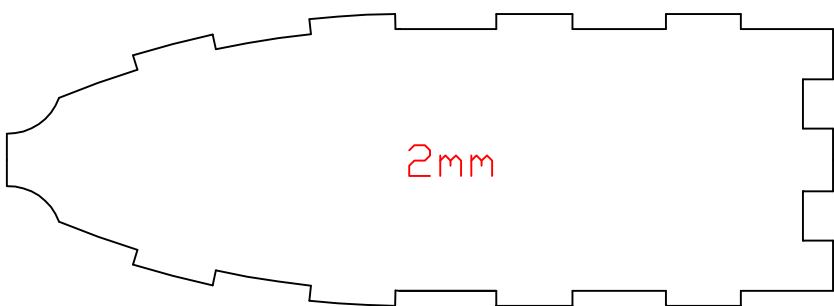
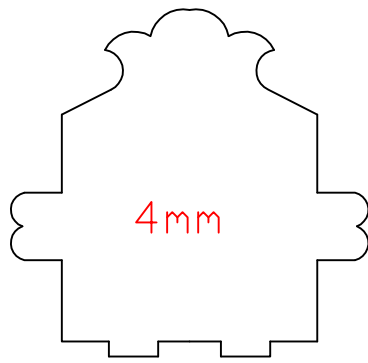
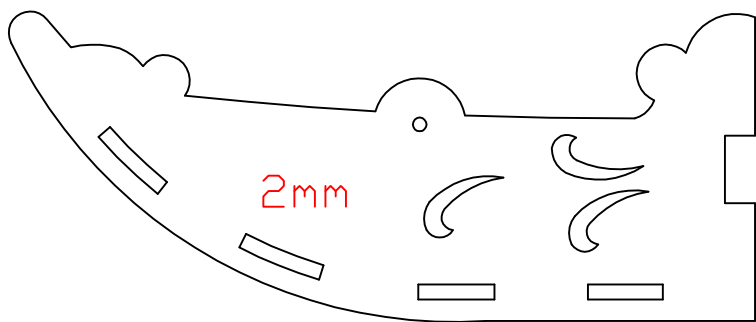
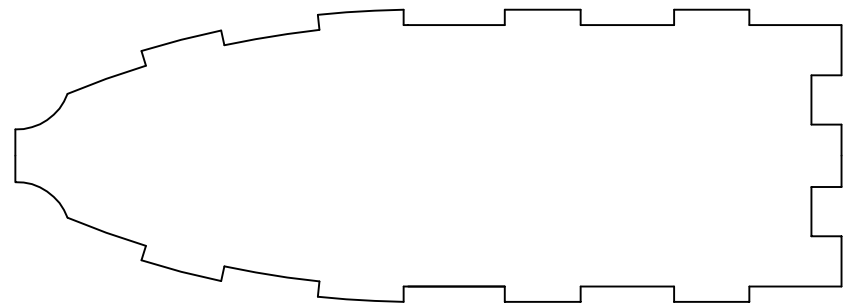
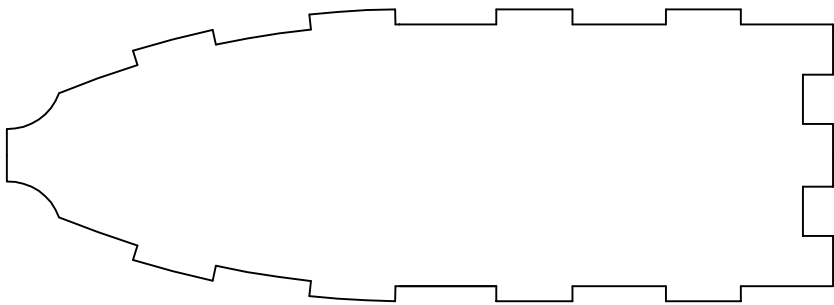
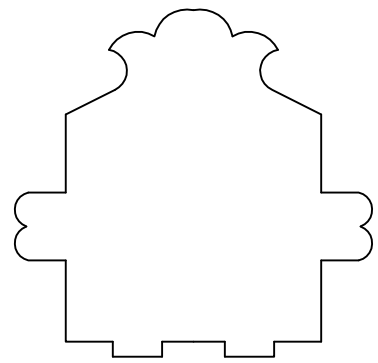
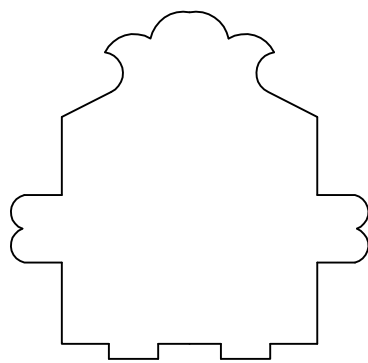
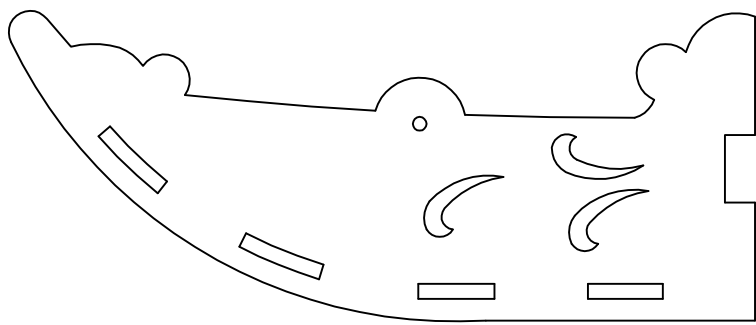
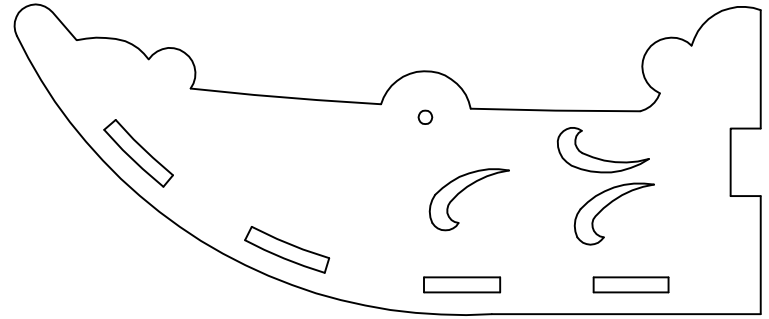
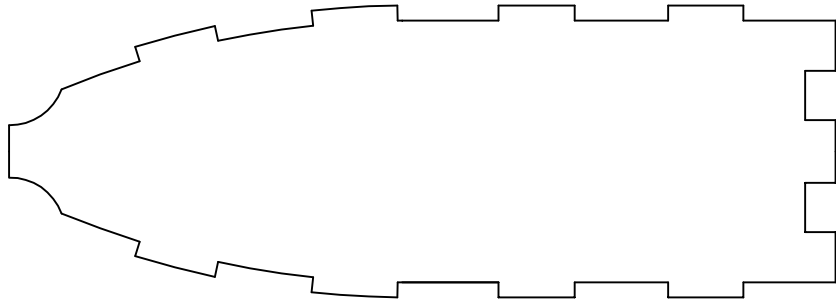
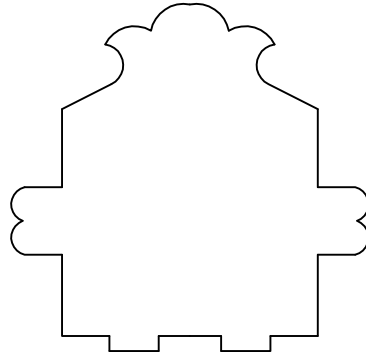
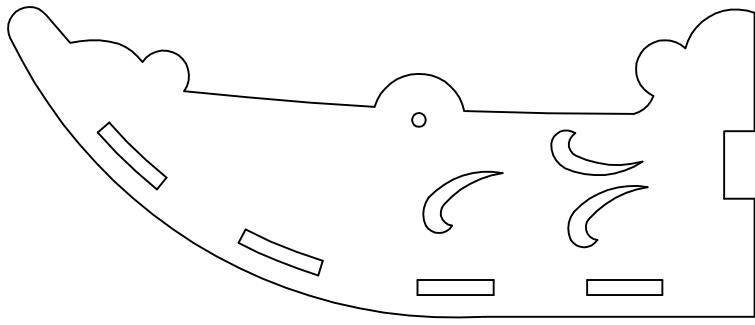

A3